

BEDROOM VOCABULARY WORD SEARCH PUZZLE !

Find and circle the words in the word search puzzle and number the pictures

g	j	v	h	d	o	b	o	o	k	c	a	s	e	w
b	q	g	f	g	r	u	g	p	v	w	r	l	o	j
l	d	l	g	r	p	z	k	t	b	o	n	j	b	r
a	r	m	c	h	a	i	r	d	e	c	w	f	r	j
n	e	f	h	k	b	w	a	r	d	r	o	b	e	m
k	s	a	g	n	s	j	h	e	q	t	w	h	z	r
e	s	n	d	r	h	h	x	s	j	z	o	z	s	t
t	i	o	y	z	e	a	l	s	t	o	o	l	n	l
u	n	s	z	y	e	u	r	e	r	w	d	j	s	j
t	g	z	m	z	t	l	v	r	v	v	g	m	i	o
z	t	u	x	n	n	z	c	u	s	h	i	o	n	h
h	a	e	d	e	s	k	m	i	r	r	o	r	h	h
m	b	z	c	w	y	x	m	l	h	h	b	t	p	h
k	l	a	m	p	i	c	h	a	i	r	x	d	e	g
a	e	a	m	y	p	e	m	w	p	i	l	l	o	w

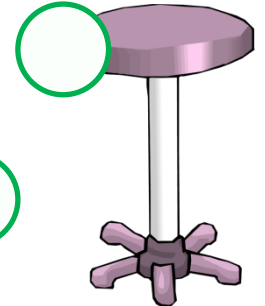
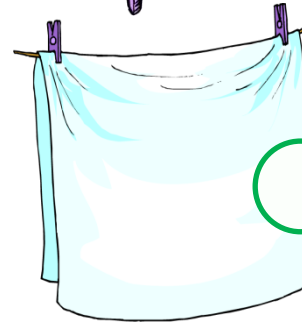
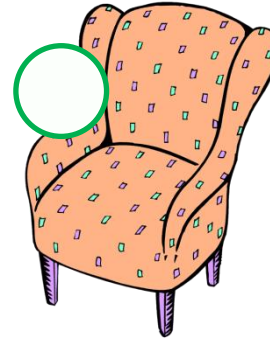
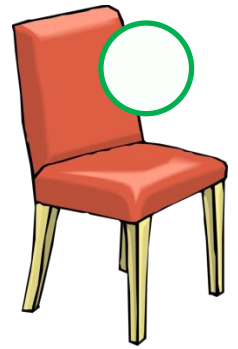

1. bed
2. sheet
3. pillow
4. blanket
5. dressing table
6. dresser
7. armchair
8. wardrobe
9. rug
10. lamp
11. desk
12. chair
13. mirror
14. cushion
15. stool
16. bookcase

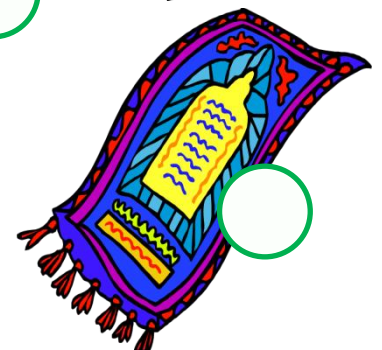
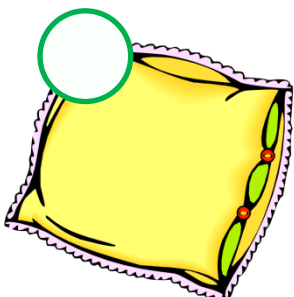
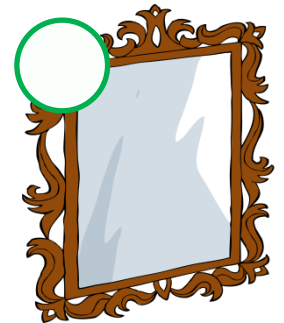
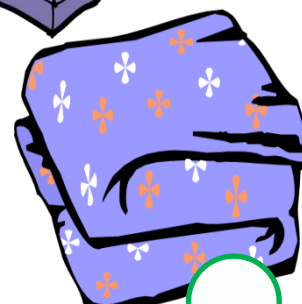
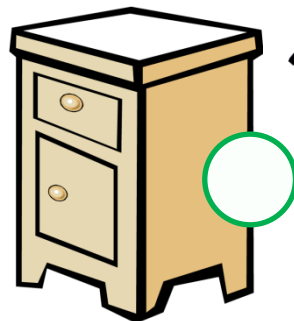
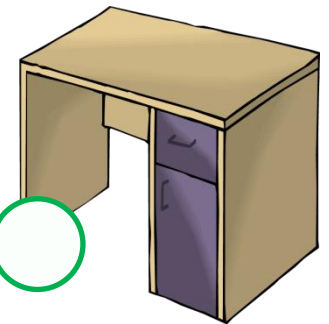
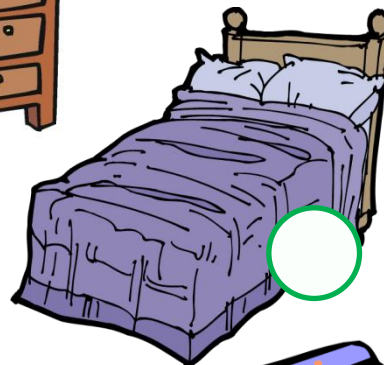
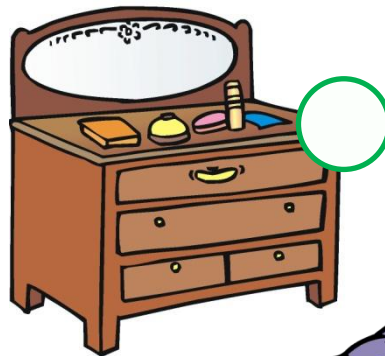

BEDROOM VOCABULARY WORD SEARCH PUZZLE 2

Find and circle the words in the word search puzzle and number the pictures

m	v	c	z	c	b	u	f	o	q	e	v	m	r	o
m	m	u	a	l	c	o	m	p	u	t	e	r	x	x
k	s	r	v	j	o	s	l	j	z	t	l	b	q	q
h	q	t	m	a	s	l	m	c	l	q	t	r	u	q
a	p	a	y	s	m	z	m	i	m	t	i	b	a	u
i	h	i	t	t	e	l	e	v	i	s	i	o	n	f
r	o	n	h	x	t	g	t	n	r	w	v	m	a	g
b	t	p	d	n	i	q	c	c	o	m	b	r	p	f
r	o	y	r	s	c	i	r	a	b	s	x	y	l	s
u	g	j	z	s	s	j	c	h	e	s	t	t	p	j
s	r	a	g	h	d	s	h	e	l	f	o	v	o	y
h	a	m	a	l	a	r	m	c	l	o	c	k	s	z
n	p	a	i	n	t	i	n	g	d	q	t	v	t	d
z	h	s	s	l	i	p	p	e	r	s	d	j	e	e
y	k	c	w	b	x	l	z	h	a	n	g	e	r	s

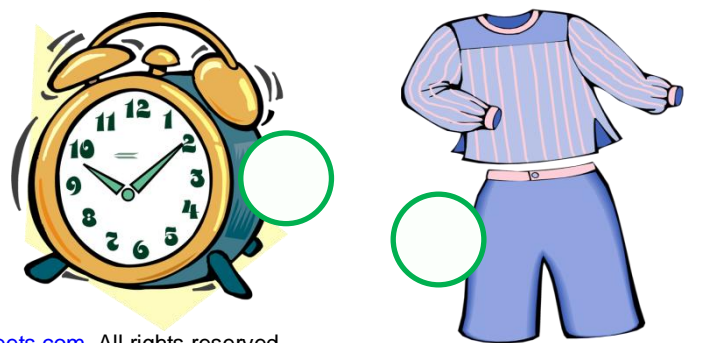
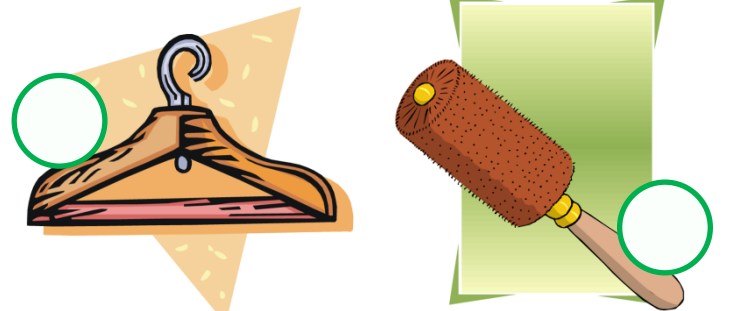
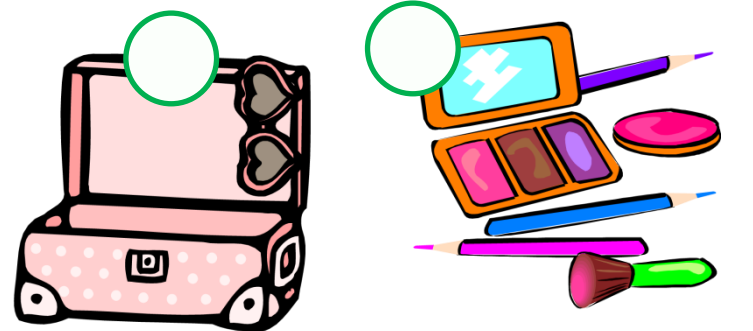
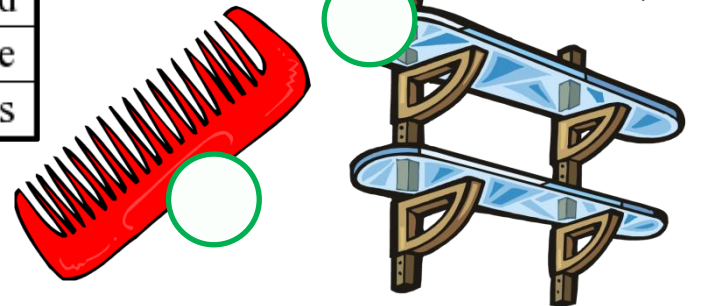

1. pyjamas
2. robe
3. cosmetics
4. comb
5. hairbrush
6. alarm clock
7. chest
8. photograph
9. painting
10. hanger
11. poster
12. slippers
13. computer
14. television
15. shelf
16. curtain

BEDROOM VOCABULARY WORD SEARCH PUZZLE | ANSWER KEY

Find and circle the words in the word search puzzle and number the pictures

g	j	v	h	d	o	b	o	o	k	c	a	s	e	w
b	q	g	f	g	r	u	g	p	v	w	r	l	o	j
l	d	l	g	r	p	z	k	t	b	o	n	j	b	r
a	r	m	c	h	a	i	r	d	e	c	w	f	r	j
n	e	f	h	k	b	w	a	r	d	r	o	b	e	m
k	s	a	g	n	s	j	h	e	q	t	w	h	z	r
e	s	n	d	r	h	h	x	s	j	z	o	z	s	t
t	i	o	y	z	e	a	l	s	t	o	o	l	n	l
u	n	s	z	y	e	u	r	e	r	w	d	j	s	j
t	g	z	m	z	t	l	v	r	v	v	g	m	i	o
z	t	u	x	n	n	z	c	u	s	h	i	o	n	h
h	a	e	d	e	s	k	m	i	r	r	o	r	h	h
m	b	z	c	w	y	x	m	l	h	h	b	t	p	h
k	l	a	m	p	i	c	h	a	i	r	x	d	e	g
a	e	a	m	y	p	e	m	w	p	i	l	l	o	w

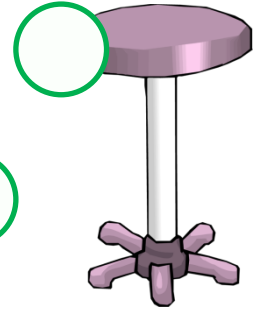
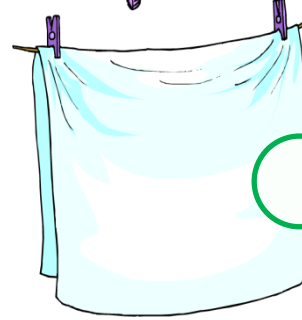
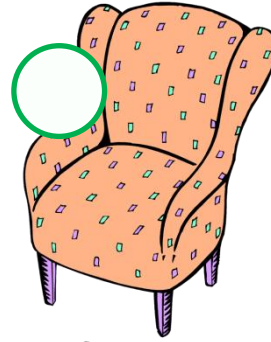
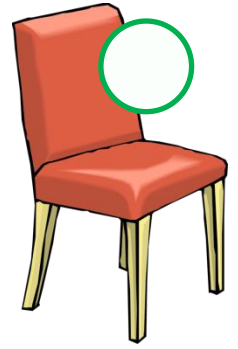

1. bed
2. sheet
3. pillow
4. blanket
5. dressing table
6. dresser
7. armchair
8. wardrobe
9. rug
10. lamp
11. desk
12. chair
13. mirror
14. cushion
15. stool
16. bookcase

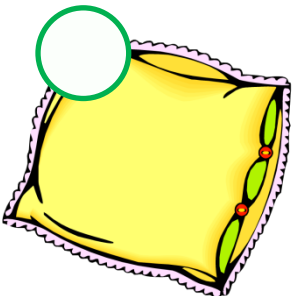
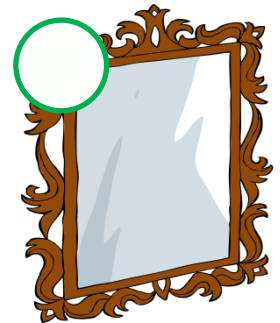
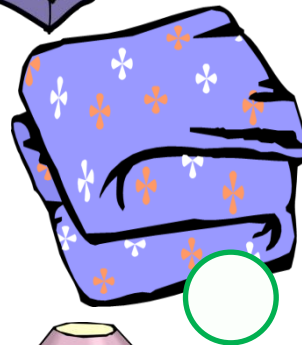
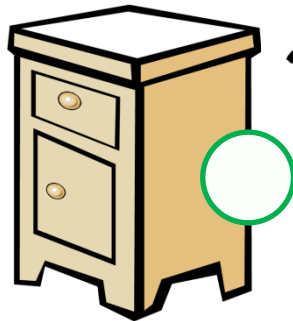
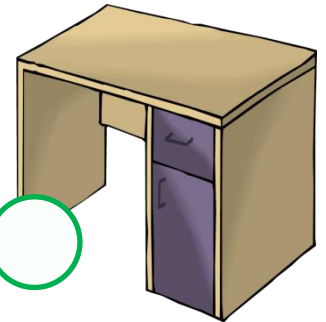
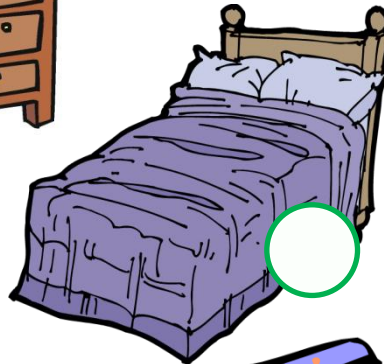
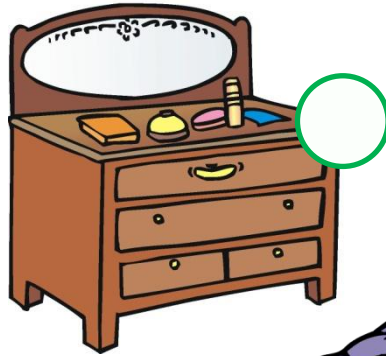

BEDROOM VOCABULARY WORD SEARCH PUZZLE 2 ANSWER KEY

Find and circle the words in the word search puzzle and number the pictures

m	v	c	z	c	b	u	f	o	q	e	v	m	r	o
m	m	u	a	l	c	o	m	p	u	t	e	r	x	x
k	s	r	v	j	o	s	l	j	z	t	l	b	q	q
h	q	t	m	a	s	l	m	c	l	q	t	r	u	q
a	p	a	y	s	m	z	m	i	m	t	i	b	a	u
i	h	i	t	t	e	l	e	v	i	s	i	o	n	f
r	o	n	h	x	t	g	t	n	r	w	v	m	a	g
b	t	p	d	n	i	q	c	c	o	m	b	r	p	f
r	o	y	r	s	c	i	r	a	b	s	x	y	l	s
u	g	j	z	s	s	j	c	h	e	s	t	t	p	j
s	r	a	g	h	d	s	h	e	l	f	o	v	o	y
h	a	m	a	l	a	r	m	c	l	o	c	k	s	z
n	p	a	i	n	t	i	n	g	d	q	t	v	t	d
z	h	s	s	l	i	p	p	e	r	s	d	j	e	e
y	k	c	w	b	x	l	z	h	a	n	g	e	r	s

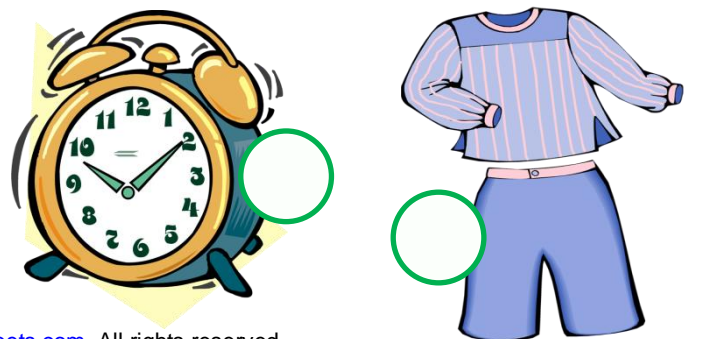
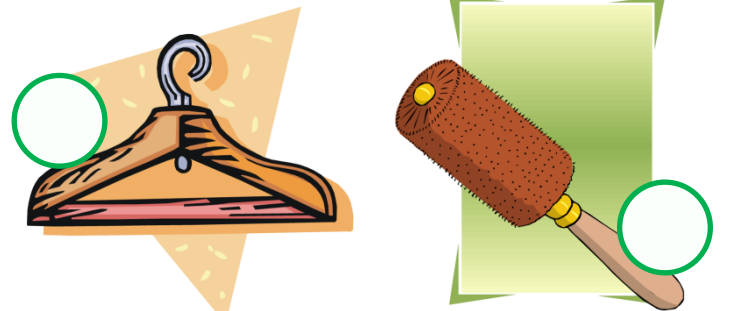
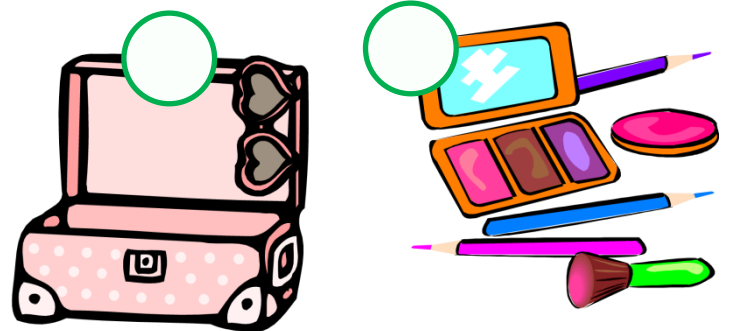
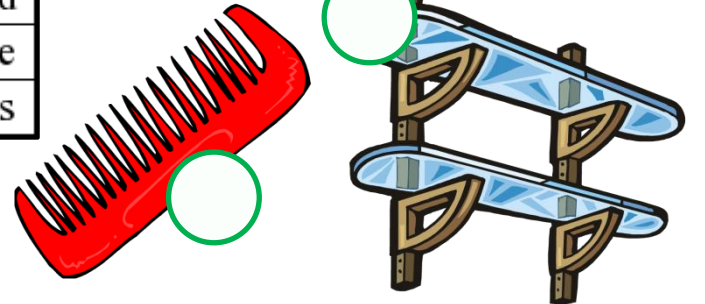

1. pyjamas
2. robe
3. cosmetics
4. comb
5. hairbrush
6. alarm clock
7. chest
8. photograph
9. painting
10. hanger
11. poster
12. slippers
13. computer
14. television
15. shelf
16. curtain